

X-150.2 D

Power Supply Voltage	10 - 16 V
Rated Power Output at 14,4 V	
-RMS power @ 4 ohm stereo	2x 150 W
-RMS power @ 2 ohm stereo	2x 250 W
-RMS power @ 4 ohm bridged	1x 500 W
Signal to Noise Ratio	>96 dB
Low Pass Crossover	40 ~ 4500 Hz
High Pass Crossover / Subsonic filter	20 ~ 4500 Hz
Frequency Response	10 Hz ~ 50 KHz (+/-1 dB)
THD@RMS Watts	< 0,028%
Channel Separation	75 dB
Fuse Rating	40 A x 1
Input Sensitivity	500 mV ~ 4 V
Dimensions	180(W) x 45(H) x 150(L) mm



X-80.4 D

Power Supply Voltage	10 - 16 V
Rated Power Output at 14,4 V	
-RMS power @ 4 ohm stereo	4x 80 W
-RMS power @ 2 ohm stereo	4x 150 W
-RMS power @ 4 ohm bridged	2x 300 W
Signal to Noise Ratio	>96 dB
Low Pass Crossover	40 ~ 4500 Hz
High Pass Crossover / Subsonic Filter	20 ~ 4500 Hz
Frequency Response	10 Hz ~ 50 KHz (+/-1 dB)
THD@RMS Watts	< 0,029%
Channel Separation	75 dB
Fuse Rating	40 A x 1
Input Sensitivity	500 mV ~ 4 V
Dimensions	180(W) x 45(H) x 150(L) mm



AUDIO SYSTEM GERMANY
FALLTORSTRASSE 6 - 76707 HAMBRÜCKEN

DESIGNED AND ENGINEERED BY AUDIO SYSTEM GERMANY

since 1988



german sound

**HIGH-PERFORMANCE
CAR-AMPLIFIER**

OWNER'S MANUAL

X SERIES
BY AUDIO SYSTEM



X-150.2 D

X-80.4 D

Congratulation on your purchase of your new X SERIES amplifier.

IMPORTANT: Before installation your power amplifier, we recommend to read the owner’s manual carefully and to follow the instructions regarding connection and fitting exactly.

ATTENTION: Pay attention to advices and instructions of the car manufacturer.

IMPORTANT: Your proof of purchase is evidence of warranty claim for repair or replacement. Keep your proof of purchase, manual and original packaging.

ATTENTION: Use of sound components can impair your ability to hear necessary traffic sounds and may constitute a hazard while driving your automobile.

AUDIO SYSTEMGERMANY accepts no liability for hearing loss, bodily injury or property damage as a result of use or misuse of our products. We recommend installing the equipment by an authorized service center or dealer. A professional fitting and connection is the requirement for further warranty and perfect sound.

X-150.2 D

- 2-Channel High-Power Full-Range Digital amplifier
- Stable into 2 ohm stereo per channel and 4 ohm bridged mode
- Variable switchable Low Pass Filter from 40 to 4500 Hz
- Variable switchable High Pass Filter from 20 to 4500 Hz
- Input Sensitivity: variable 500 mV maximum to 4 V minimum
- Multi-Way Protection Circuitry: overheating, overcurrent, short circuitry and speaker DC protection
- Operating Voltage : DC 10 ~ 16 V power input
- Wired Remote Control **RTC** (optional)
- High-Power-Input (normally original radio) with automatically „Turn-On“
- Adaptercable **HLAC** and **RCA HI** (optional)



X-80.4 D

- 4-Channel High-Power Full-Range Digital amplifier
- Stable into 2 ohm stereo per channel and 4 ohm bridged mode
- Variable switchable Low Pass Filter from 40 to 4500 Hz
- Variable switchable High Pass Filter from 20 to 4500 Hz
- Input Sensitivity: variable 500 mV maximum to 4 V minimum
- Multi-Way Protection Circuitry: overheating, overcurrent, short circuitry and speaker DC protection
- Operating Voltage : DC 10 ~ 16 V power input
- Wired Remote Control **RTC** (optional)
- High-Power-Input (normally original radio) with automatically „Turn-On“
- Adaptercable **HLAC** and **RCA HI** (optional)



This power amplifier is featured with an efficient protection system to prevent any damages like over-heating, overvoltage, short-circuit and DC at the loudspeaker output. Occuring an error the protection-LED will light in red. In order to check the problem, first turn down all levels of the head unit, afterwards turn it off.

AMPLIFIER IS NOT POWERED UP, NO LED IS LIGHTENING	<ul style="list-style-type: none"> - ground connection professional connected? - +12V powercable professional connected? - remote cable professional connected? - fuses inserted and alright? - analyze voltage on the amplifier.
PROTECTION LED ILLUMINATES GREEN WHILE AMPLIFIER IS SOUNDLESS	<ul style="list-style-type: none"> - cinch cable alrith and professional connected - loudspeaker professional connected? - head unit alright?
PROTECTION LED ILLUMINATES RED WHEN AMPLIFIER IS POWERED UP	<ul style="list-style-type: none"> - amplifier too hot? - short-circuit at the loudspeaker output? - short-circuit caused by loudspeaker cable with vehicle chassi (ground)? - input voltage too high (e.g.faulty generator)?
OVERHEATING (PROTECTION LED ILLUMINATES RED WHEN AMPLIFIER IS POWERED UP)	<ul style="list-style-type: none"> - impedance alright? - loudspeaker error? - adequate airflow of the amplifier? <p style="text-align: center;">! CAUTION ! After cooling down, the amplifier turns on automatically.</p>
ERROR IN AMPLIFIER FUSE	<ul style="list-style-type: none"> - ground professional connected? - loudspeaker impedance alright? <p style="text-align: center;">! CAUTION ! Make sure when changing fuses to use the same value.</p>
SOUND TOO LOW OR LOW-DISTORTED SOUND	<ul style="list-style-type: none"> - input level control “GAIN” is set to match the head unit? - output level control of the head unit alright? - loudspeaker error? - loudspeaker cable checked? - crossover frequencies has been properly set? (Check head unit, amplilfier, DSP, soundprozessor, equalizer, frequency bandpassfilter...)
HIGH HISS-ENGINE NOISE IN SPEAKERS	<ul style="list-style-type: none"> - ground connection professional connected? - short-circuit caused by loudspeaker cable with vehicle chassi (ground)? - cinchcable (RCA) and/or loudspeaker cabel installed too close to the power connection cable? - cinch ground (RCA) of the head unit alright?

⚠ ATTENTION ⚠

Please contact your specialized dealer if the amplifier is still not working after it has been checked with the error list!

For warranty adjustement / repairs the original invoice has to be attached!
Opening the power amplifier is leading to a lost of warranty in either case!

X-80.4 D

2-Channel Mono

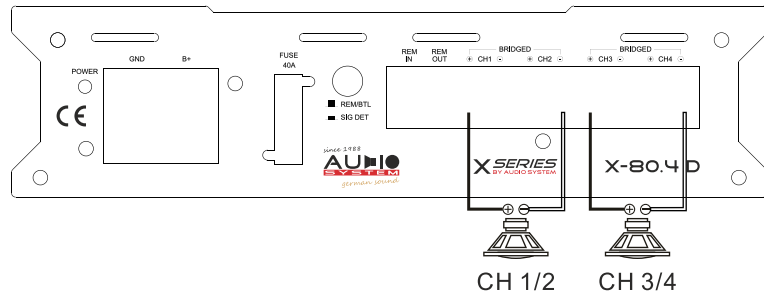

Speaker Impedance
4 ~ 8 Ohm

4-Channel Stereo

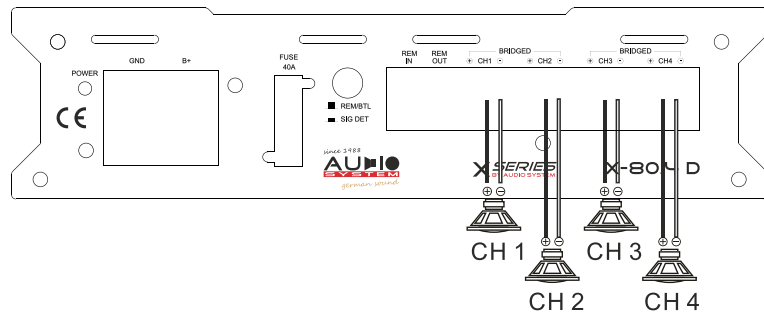

Speaker Impedance
2 ~ 8 Ohm

2-Channel Stereo + 1-Channel Mono Bridged

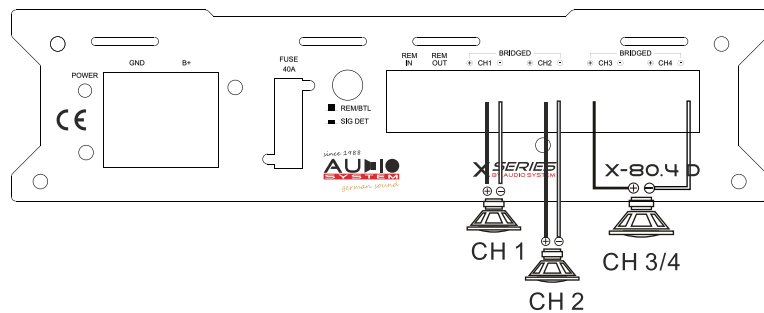

Speaker Impedance
4 ~ 8 Ohm

X-150.2 D / X-80.4 D

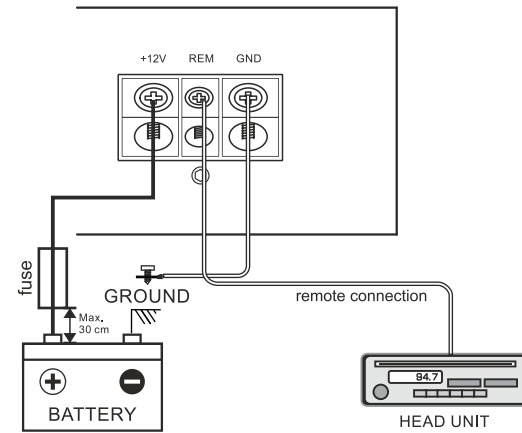

1. Battery disconnection:
First, disconnect the power supply of the vehicle by removing the ground cable of the battery.

2. Ground connection:
Connect the GND (ground) connection of the amplifier with the car chassis. Keep this cable as short as possible (not longer than 50 cm) and use a suitable cross section (AWG size 8-6). Make sure, that the connection with the vehicle chassis is free of paint, dirt and dust.

3. +12 V Power connection:

Connect the +12 V contact of the amplifier with the supply cable via a fuse directly to the vehicle battery. Keep in mind, that the length of the cable from fuseholder to vehicle battery has to be maximum 30cm. For the amplifier to function at its best, use a high quality fuse holder and suitable cable preferably AWG 8-6 cable. This fuse protects the amplifier and the vehicle against the possibility of a short circuit in the power cable.

4. Remote connection:

Connect the REM-terminal of the amplifier to the remote-output (automatic 12 V antenna-output) of the head unit. Use a 0,5 - 1,5 mm power cable.

⚠ ATTENTION ⚠

Please follow the instructions during the installation of your amplifier:

- Take care of a professional attachment. Pay attention, that no electrical cable, gas tank, hydraulic brakes or other components get damaged.
- There has to be enough cooling and air circulation. Avoid the installation in small closed boxes or close to heating parts.
- Protect the amplifier from fluids, wetness, heat and foreign material as well as from other influences.
- The amplifier is only to be built into vehicles with a 12 V DC power supply.
- Never install the power supply cable with other original wires of the vehicle (gas cables), fan motors, brand control moduls etc.
- Install the signal cable (cinch cable) as well as the speaker cable far away of the power cables to avoid troubles with the music signal.
- The cables of your amplifier have to be installed, so that there is no danger of binding, squeezing or breaking.

X-150.2 D

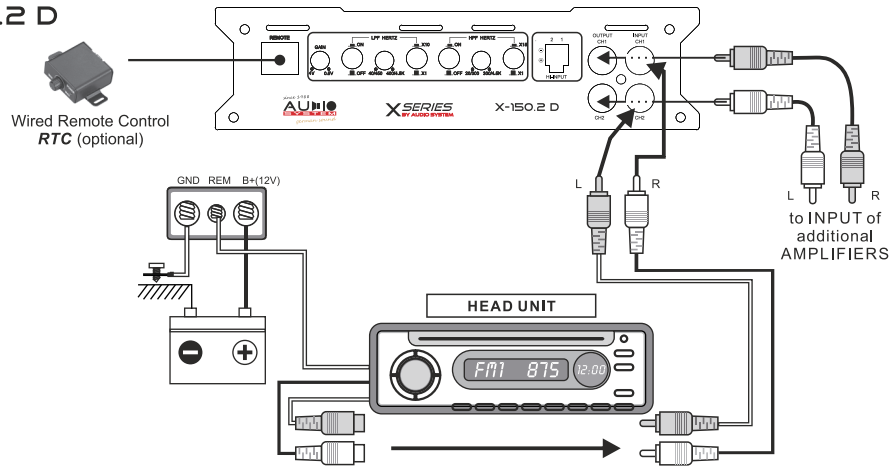

X-80.4 D

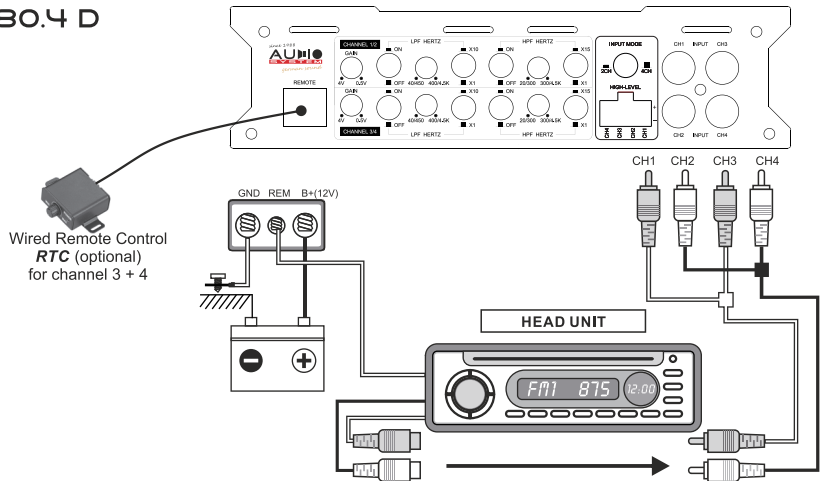

The **X SERIES** amplifier offers RCA-Inputs, which are connected through cinch cables with the preamplifier-outputs of the head unit. If the head unit (OEM-RADIO) has no RCA-Output, than it is possible to connect the speaker output direct to RCA/Cinch-Input. **Important:** the Gain-Controller has to be adjusted to minimum, then carefully turn up the volume. Input Mode has to be switched on „HI“. If signal is presented, the amplifier automacally turns on. Adaptercable **HLAC** and **RCA HI** can be purchased at your specialized dealer. The RCA-outputs provide the possibility to transfer the signal of the head unit to a 2. amplifier via a cinch cable (not possible for **X-80.4 D**). With the aid of the shiftable high- and low pass filter, the gain-controller and the bassboost you are able to adjust the amplifier on to your preferred taste of hearing, the circumstances of the vehicle and to the speakers. In this regard, **AUDIO SYSTEM GERMANY** recommends to adjust your amplifier through a specialized service center, dealer or a specialist.

X 150.2 D

1-Channel Bridged

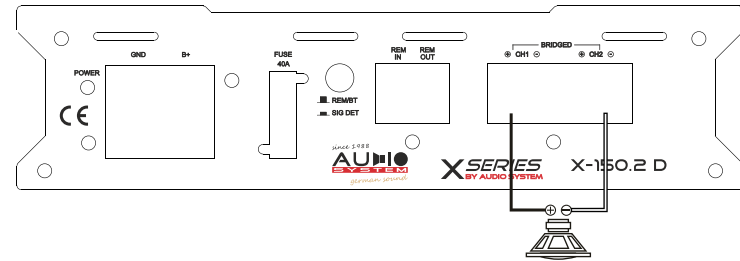

Speaker Impedance
4 ~ 8 Ohm

2-Channel Stereo

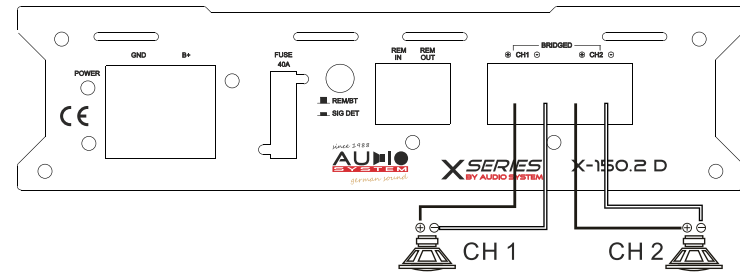

Speaker Impedance
2 ~ 8 Ohm

Tri-Mode

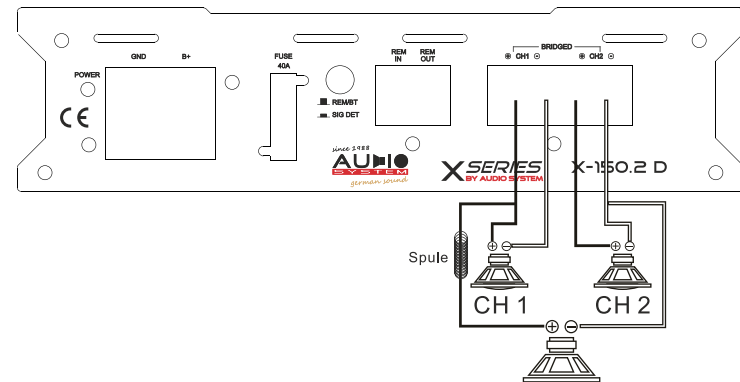

Speaker Impedance
4 ~ 8 Ohm